

ERV Heat Recovery Ventilation

ERV

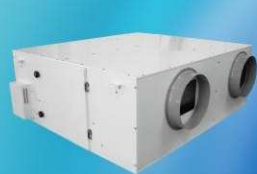

ERV-800
ERV-1000
ERV-1500
ERV-2000



ERV-250
ERV-350
ERV-500



ERV-500L



ERV-150

■ DESCRIPTIONS

ERV Heat Recovery Ventilation is specially designed for ventilation of internal rooms in commercial, household, educational and leisure applications and ensures the effective use of energy.

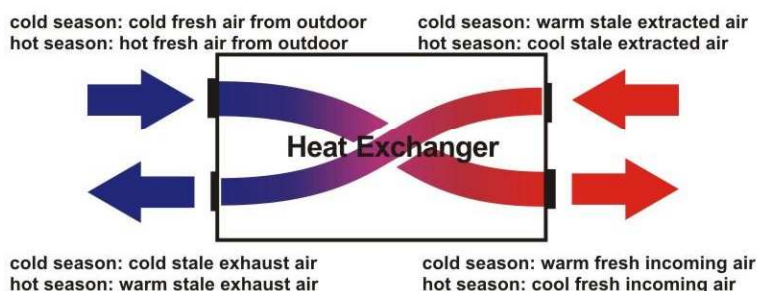

■ FEATURES & BENEFITS

- The system provides a continuous supply of fresh clean air ensuring excellent indoor air quality and prevent energy loss with up to 70% heat recovery.
- Low power consumption, quiet operation and speed controllable with high efficiency DC motor
- Provides efficient condensation control and eradication of mould growth
- Expels indoor odour and air pollutants
- Improves energy saving

■ SPECIFICATIONS (220V~50Hz)

Model	Speed	Power (w)	Air Volume (m ³ /h)	Efficiency (%)	Sound level (dB)
ERV-150	High	58	150	70	40
	Middle	42	105		
	Low	27	80		
ERV-250	High	80	250	70	40
	Middle	56	185		
	Low	44	130		
ERV-350	High	113	350	70	40
	Middle	93	310		
	Low	63	220		
ERV-500	High	197	500	70	50
	Middle	118	380		
	Low	82	290		
ERV-800	High	277	800	70	60
	Middle	200	660		
	Low	145	500		
ERV-1000	High	432	1000	70	60
	Middle	272	820		
	Low	170	600		
ERV-1500	High	1000	1500	70	65
	Middle	800	1200		
	Low	700	700		
ERV-2000	High	1300	2000	70	65
	Middle	1000	1520		
	Low	900	1400		

■ PERFORMANCE CURVE (220V~50Hz)

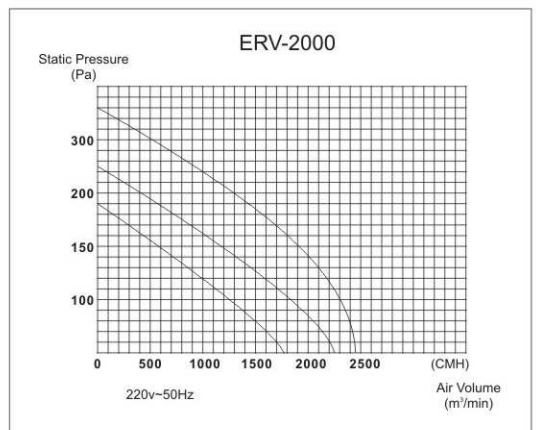
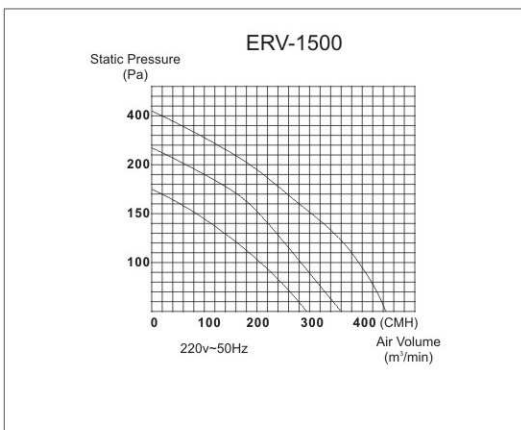
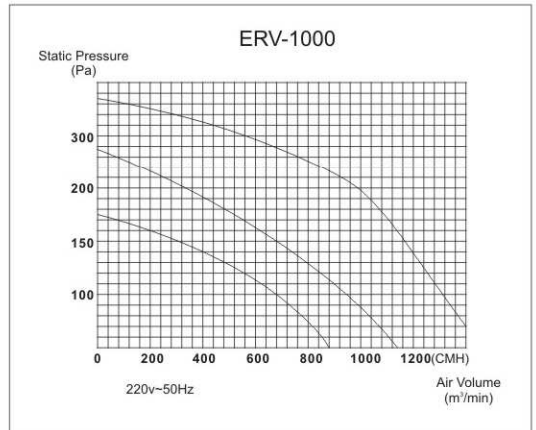
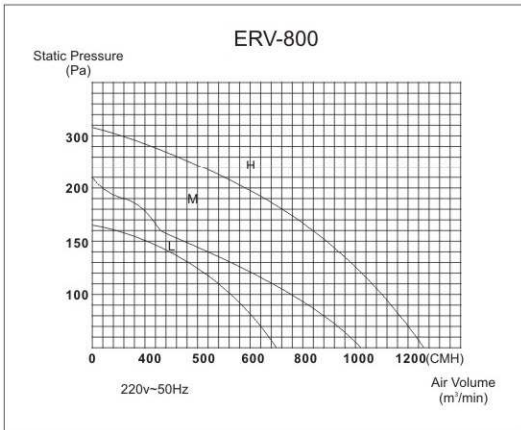
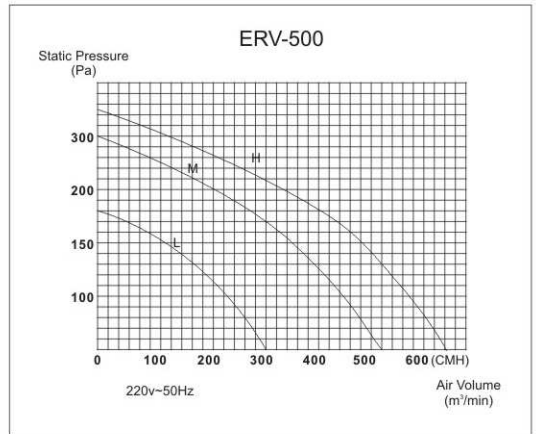
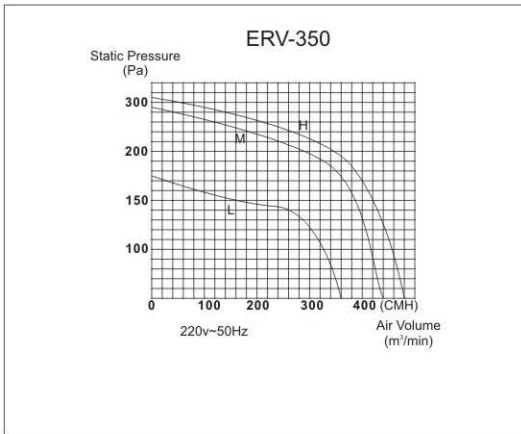
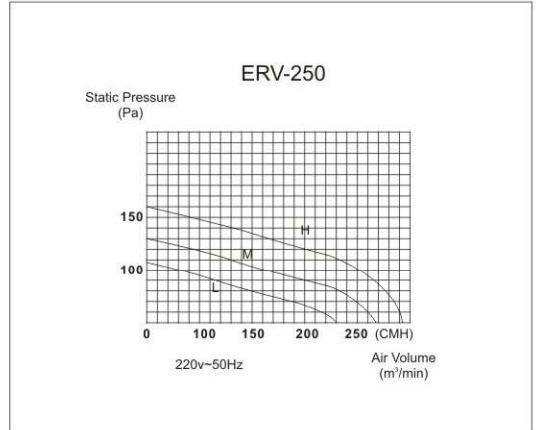
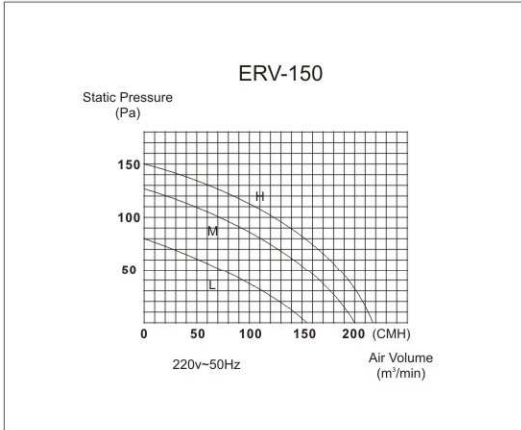

■ DIMENSIONS (mm)

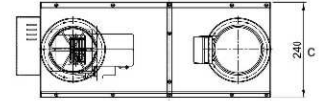
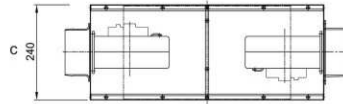
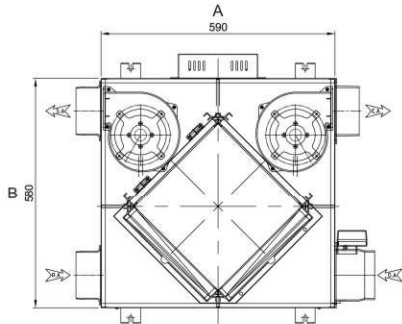

ERV-150 (150CMH)

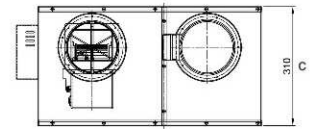
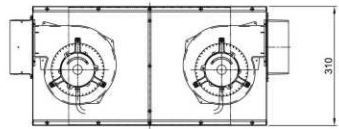
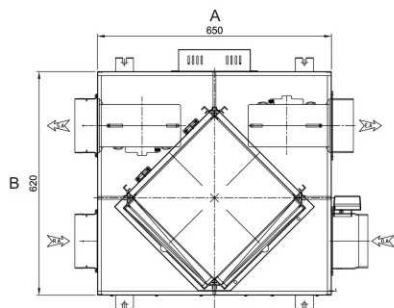

ERV-250 (250CMH)

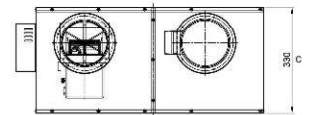
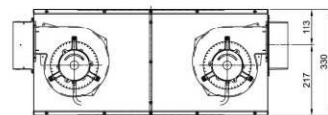
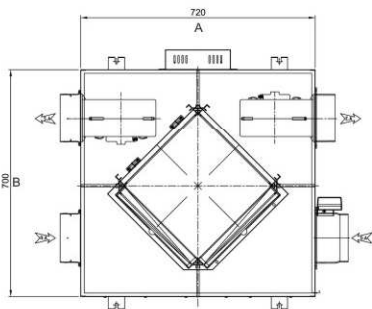

ERV-350 (350CMH)

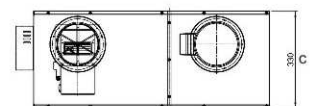
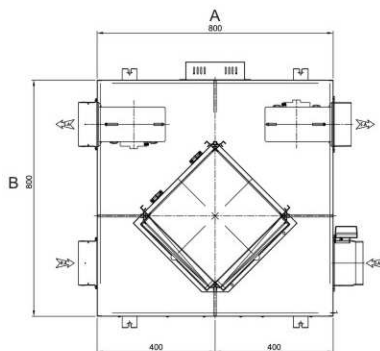

ERV-500 (500CMH)

■ DIMENSIONS (mm)

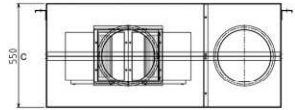
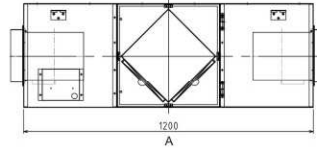
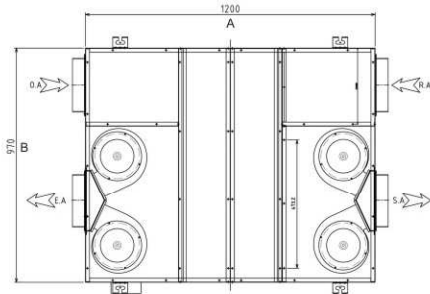

ERV-800 (800CMH)

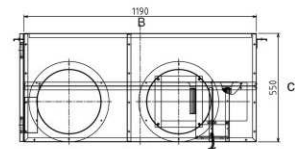
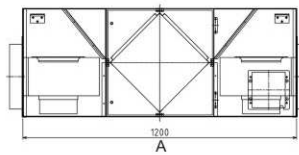
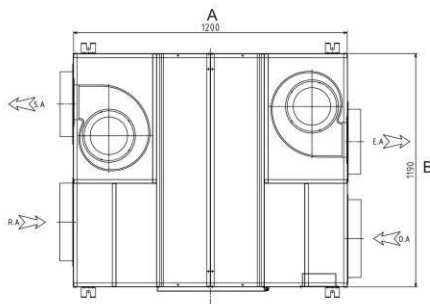

ERV-1000 (1000CMH)

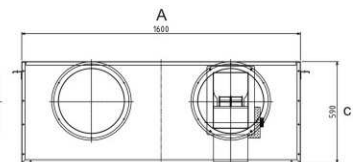
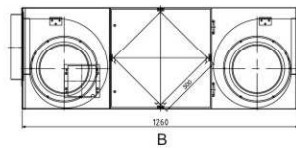
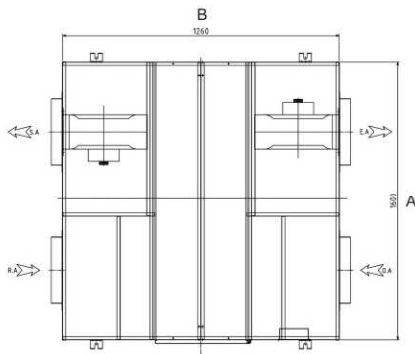

ERV-1500 (1500CMH)

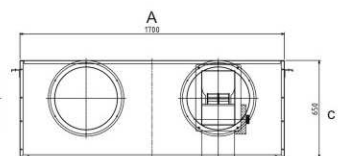
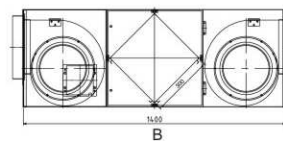
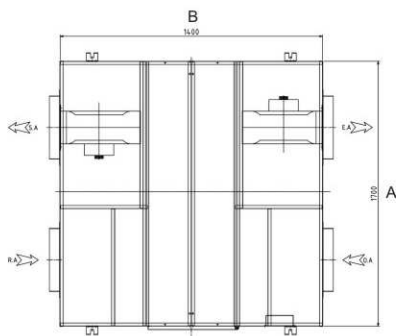

ERV-2000 (2000CMH)

■ DIMENSIONS (mm)

Model	A	B	C	Heat Exchanger	Connector	Damper	Bdd
ERV-150	590	580	240	300x300x230	∅ 125	∅ 125	∅ 125
ERV-250	650	620	310	320x320x300	∅ 150	∅ 150	∅ 150
ERV-350	720	700	330	380x380x330	∅ 150	∅ 150	∅ 150
ERV-500	800	800	330	460x460x330	∅ 150	∅ 150	∅ 150
ERV-800	1200	970	550	320x320x480	∅ 200		
ERV-1000	1200	1190	550	320x320x590	∅ 250		
ERV-1500	1600	1260	590	350x350x790	∅ 300		
ERV-2000	1700	1400	659	380x380x840	∅ 350		

■ ACCESSORIES



motorized damper
(optional)



controller



IMS International Ltd.

Unit 1,39/F., Cable TV Tower, 9 Hoi Shing Road, Tsuen Wan, N. T., Hong Kong.

Tel: 852-2881 8011

Fax: 852-2894 8682

Email: sales@imasu.com

Website: www.imasu.com

* Specifications are subject to alter without prior notice due to continuous product improvement